

Manual

DVP050
DVP100
DVP170



Visit www.duratech.be for other available languages

06-03-23

VISION Pro

welldana
● ● ●

Table of contents

Technical specifications	Page 4
Remarks	Page 5-6
Box contents	Page 7
Installation instructions	Page 10-11
Installation specialties	Page 12-13
Wiring instructions setup 1	Page 14-15
Wiring instructions setup 2	Page 16-17
Wiring remarks	Page 18-19
Synchronizing	Page 20
Color programs	Page 21
Troubleshooting	Page 22

Technical specifications

Lamp Type	Description	Voltage	Power	Color temp	Luminous flux*
DVP050-RGBW	All colours and Tunable white	10-14 VAC	33 W	n.a.	1200 lm
DVP100-RGBW	All colours and Tunable white	10-14 VAC	85 W	n.a.	3500 lm
DVP170-RGBW	All colours and Tunable white	10-14 VAC	180 W	n.a.	7000 lm

(*) Propulsion systems remains a tolerance of +/- 10% on luminous flux measurements @ 25°C ; 12VAC



For operation only with a safety isolation transformer

Minimum input voltage: **10 VAC 50/60 Hz**
(at lamp terminals)

Nominal input voltage: **12 VAC 50/60 Hz**
(at lamp terminals)

Maximum input voltage: **14 VAC 50/60 Hz**
(at lamp terminals)



IEC Protection Class III

Operation on DC voltages is NOT allowed

Maximum water temperature: **+40°C**
Lamps have to be kept out of ice zones

Ingress protection rate: **IP68**
measured at 3m max depth = 3m

Remarks

Water conditions

Prevent damage to your pool lamps and wires due to unstable water conditions. Your local government may have enacted guidelines for your pool water conditions to apply by. If not we strongly advise the following parameter specifications to be applied:

pH level	6,8 - 7,6
Free Chlorine	max. 3ppm
Combined chlorine	max. 1 ppm
Water temperature	max +40°C and lamps need to be kept out of ice zones

Always adhere to the instructions provided by your chemical brand/supplier for the correct use and application of pool chemicals.

Salt water pools, or pools fitted with a salt water chlorine generator contain salt in the pool water. Salt is a corrosive material. Overdosage and/or consistent levels of salt increase the possibility of deterioration of your pool lamps and cables. As a rule of thumb, a concentration of 35gr/l salt can be accepted when pH values are between 7,2-7,4.

In any case, we urge proper use, care and maintenance of your installation, in order to minimize the effect of corrosion and deterioration.

Please be aware that pool lamps and cables with defects caused due to abnormalities in the water condition are not covered by our factory warranty.

Installation/maintenance

The luminaire is maintenance free

If the luminaire needs to be replaced, it needs to be completely removed from the water



If the external flexible cable or cord of this luminaire is damaged, it shall be exclusively replaced by the manufacturer or his service agent or a similar qualified person in order to avoid hazard



VISION Pro Pool lamps must be completely submerged into water during operation. Fixing the lamps with adhesives or silicone kit into a niche is not allowed. Not following these instructions, will void warranty.

Box contents

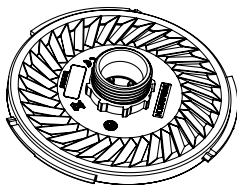

VISION Pro lamp
(50, 100 or 170 mm)

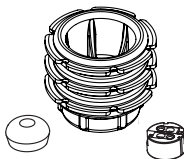

Connection Kit*

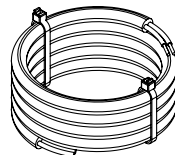

2m Cable**



Manual

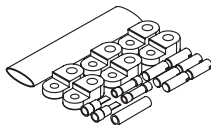

Retrofit Kit
(only for 170mm models)

*
**

Lamp type	Connection kit	Cable
DVP050-RGBW	513-0480 ; 1 washer for fixnut ; blue cable gasket	1 mm ²
DVP100-RGBW	513-0636 ; 2 washers for fixnut ; orange cable gasket	1,5 mm ²
DVP170-RGBW	513-0393 ; 3 washers for fixnut ; green cable gasket	2,5 mm ²

Installation instructions

Installing faceplate

Toolset _____
(not included)

Contact your local
distributor for a
toolset (513-0151)

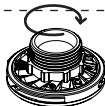
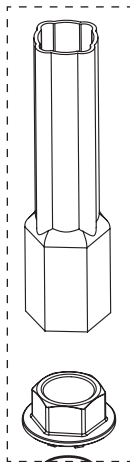

Lamp _____

Face Plate _____

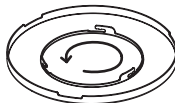

Installation instructions

Installing connector

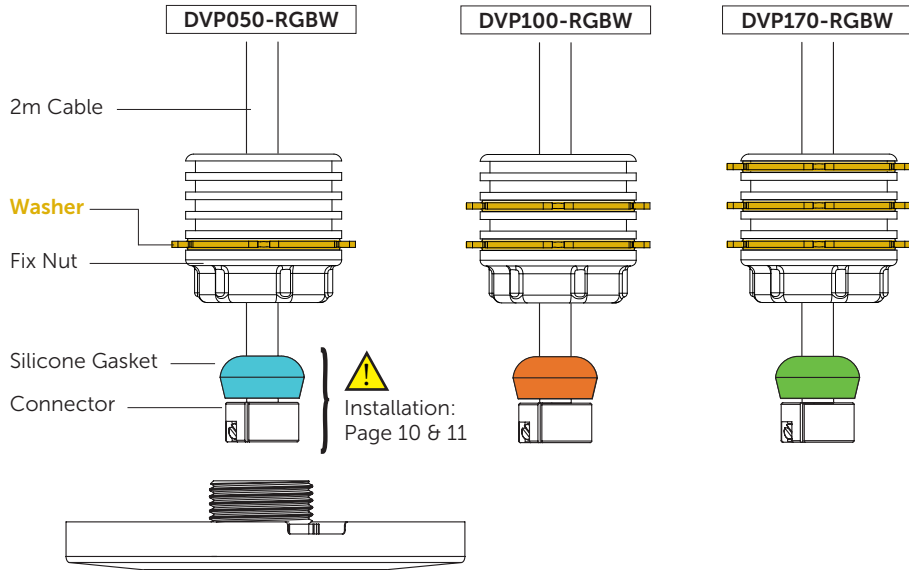

Connector installation

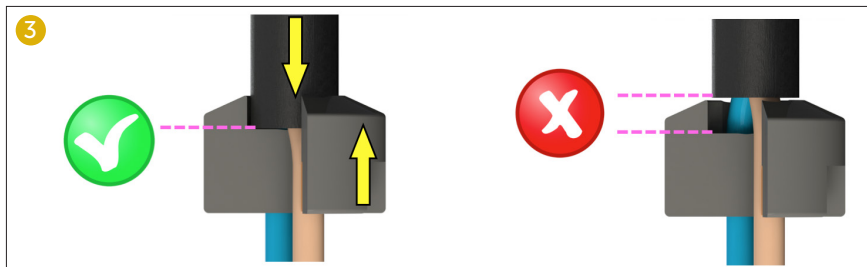
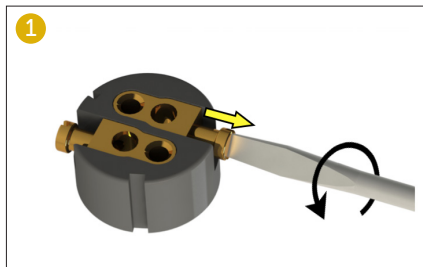



Installation specialties

DVP050 & PZA-WG

For installations with DVP050 & PZA-WG-S or PZA-WG-G:
Please make sure to **only use 1 silicone washer** for the Fix nut

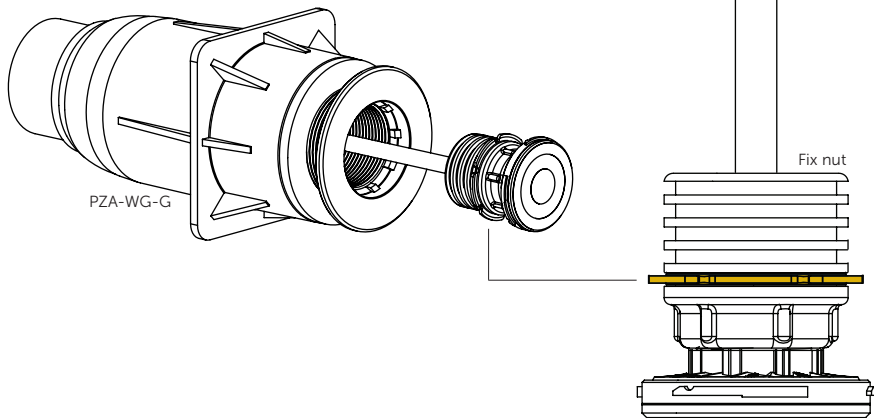

DVP050 Removal tool

When DVP050 needs to be removed from the PZA-WG wall conduits, a special tool is needed (513-0491)*

1. Insert the tool over the lamp, straight into the wall conduit
2. Twist the tool counter clockwise the lamp should be snapped into the 3 hooks of the tool
3. Pull the lamp straight out of the wall conduit

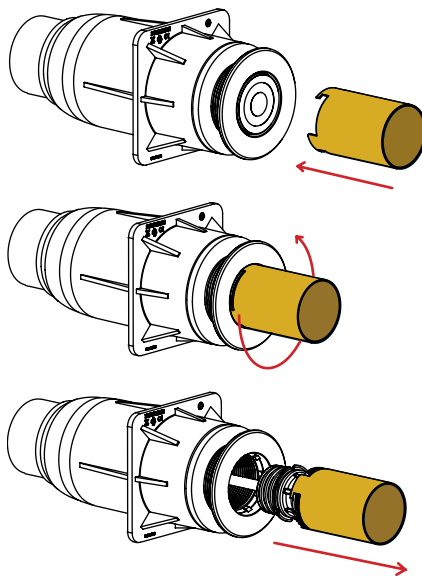

* Available separately

Wiring instructions Setup 1

For new installations



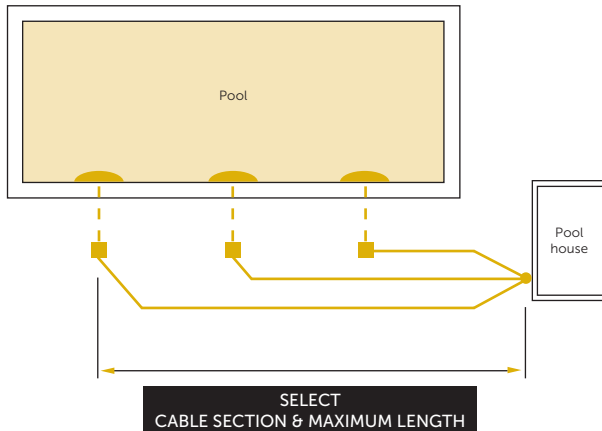



Each lamp is connected to the transformer by a separate cable



- - - - 2m cable included in lamp package
- Separate cable (not included)



Always use a toroidal transformer

		SELECT CABLE SECTION & MAXIMUM LENGTH					
LAMP TYPE		1,5mm ²	2,5mm ²	4,0mm ²	6,0mm ²	10mm ²	VA TRANSFORMER (12VAC)*
	 DVP050-RGBW	23m	35m	60m	95m	155m	43 VA
	 DVP100-RGBW	9m	15m	24m	35m	60m	111 VA
	 DVP170-RGBW	4m	7m	11m	17m	29m	234 VA

STABLE OPERATION OF THE POOL LIGHTS IS ONLY GUARANTEED WHEN THE INSTALLED CABLE CROSS SECTION MATCHES OR EXCEEDS THE ADVISED VALUES IN THE ABOVE TABLE

* The transformer VA rating must be greater or equal to the sum of VA ratings of all connected lamps. These cable lengths are calculated with worst case voltage drops in the electrical wiring.

Wiring instructions Setup 2

For existing or other installations



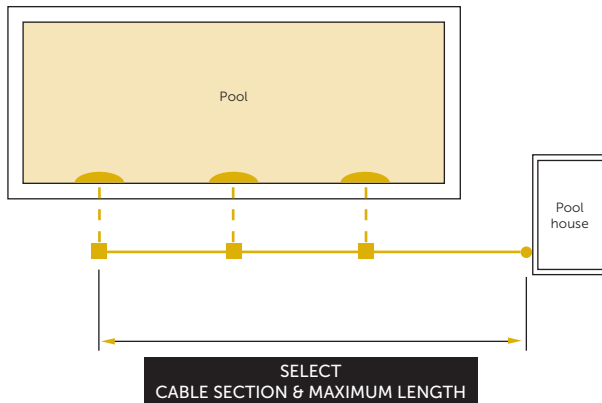



All lamps are connected to the transformer via 1 cable



- 2m cable included in lamp package
- Separate cable (not included)



Always use a toroidal transformer

		SELECT CABLE SECTION & MAXIMUM LENGTH					
LAMP TYPE	QTY	2,5mm ²	4,0mm ²	6,0mm ²	10mm ²	VA TRANSFORMER (12VAC)	
  DVP050-RGBW	1	35m	60m	95m	155m	43	
	2	18m	30m	48m	78m	86	
	3	12m	20m	32m	52m	129	
	4	9m	10m	24m	39m	172	
  DVP100-RGBW	1	15m	24m	35m	60m	111	
	2	8m	12m	18m	30m	221	
	3	5m	8m	12m	20m	332	
	4	4m	6m	9m	15m	442	
  DVP170-RGBW	1	7m	11m	17m	29m	234	
	2	4m	6m	9m	15m	468	
	3	2m	4m	6m	10m	702	
	4	2m	3m	4m	7m	936	

STABLE OPERATION OF THE POOL LIGHTS IS ONLY GUARANTEED WHEN THE INSTALLED CABLE CROSS SECTION MATCHES OR EXCEEDS THE ADVISED VALUES IN THE ABOVE TABLE

Wiring remarks

For installations with LINK **Controller** or LINK **Master**

Third party equipment such as frequency inverters and electric motors can generate excessive noise on the 230VAC / 400VAC power line.

This noise might be injected into the adjacent 12VAC power line and disturb the power line communication towards the VISION Pro RGBW lights.

To prevent this, please take care of the following:



Keep 230VAC / 400VAC power line cables at least 50cm separated over their full length from the 12VAC power line towards any RGB lights



Do not mix 12VAC and 230VAC / 400VAC power line cables into the same cable trays

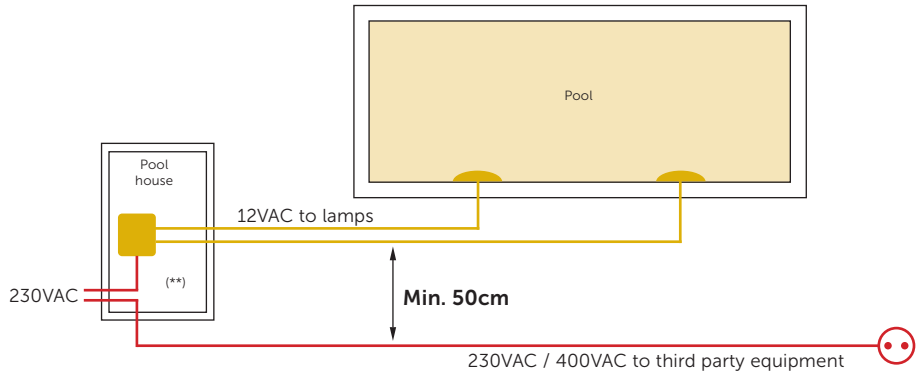

() Do not mix 12VAC and 230VAC / 400VAC power line cables into the same cable trays**

Synchronizing



With LinkTouch

- + LINK Controller (PLP-REM or PLP-REM-350)*
- + LINK Master (DLM450 or DLM600)

First make sure the LinkTouch is paired (see manual LinkTouch)

Turn the lamps on and spin the color wheel on the LinkTouch until the lamps react. If the lamps do not react, turn them off and back on until they react to the color wheel. As soon as the lamps follow the color wheel: wait 1 minute. The lamps are now synced.



With Transmitter

- + LINK Controller (PLP-REM or PLP-REM-350)*

Turn the lamps on and push the UP button 10 times. Wait for 20 seconds, then turn the lamps off. Repeat this process until the lamps react to the remote. As soon as the lamps follow the remote: wait 1 minute. The lamps are now synced.

Manual synchronization (without DURALINK control products)

1. Switch ON the 12 VAC line voltage and make sure that all lamps light up.
2. Switch OFF the 12 VAC line voltage and wait for at least 1 minute
3. Switch ON
4. The lamps should now all be on color program 1: Blue

*PLP-REM or PLP-REM-350 need to have firmware V6.7 (29-07-20) or newer

Color programs



RGBW LAMPS

1	DEEP BLUE SEA	Saturated blue
2	DAYLIGHT BLUE	Light blue
3	SUNSET	Slow animation orange - red
4	LOVE IS IN THE AIR	Red
5	FOREST SPRING	Green
6	THINK PINK	Pink
7	SUNSHINE	Yellow
8	JUNGLE BEACH	Slow animation blue & green tints
9	VOODOO	Slow animation red & purple tints
10	DISCO	Fast animation lila-pink-peach-yellow-green blue
11	PARTY	Fast animation blue-green-red-pink-yellow-green
12	WARM WHITE	3000K
13	NEUTRAL WHITE	6000K
14	SUN WHITE	10.500K

- fixed colors
- dynamic colors
- white tints

*all color programs are dimmable if LINK **Touch**, LINK **Controller** or LINK **Master** are used (in PLC mode)

Troubleshooting

PROBLEM

- The pool light is flickering

SOLUTION

1. Switch the lamps ON and select Cold white color program
2. Remove the lamp from the water, unscrew the fix nut, pull back the gasket and the black cable jacket, so you can reach the brass contacts inside the connector block (do not remove the connector block)
3. Measure the voltage at the lamp terminals (while the lamp is still ON)
4. The voltage at the lamp should be at least 10VAC 50/60Hz.
If the measured line voltage is below 10VAC:
 - A. Check the output voltage at the transformer terminals. This voltage should be between 12VAC and 14VAC. Verify that the used transformer VA rating is sufficient for powering all connected lamps
 - B. If the transformer output voltage is ok, then install a thicker cable between the transformer and the lamp. (wiring instructions p. 14-19)

-
- Several pool lights in the pool show different color programs

Make sure that all lamps are connected to the same 12VAC power line. Execute the synchronization as explained on p.20

-
- The lamp is flashing red

The lamp is exposed to an overvoltage. Consult an electrician to verify the installation and to make sure the voltage at the lamp side is below 14VAC.

Declaration of Conformity

Declarations of conformity covering this product are available for download from the House of Duratech website: www.duratech.be

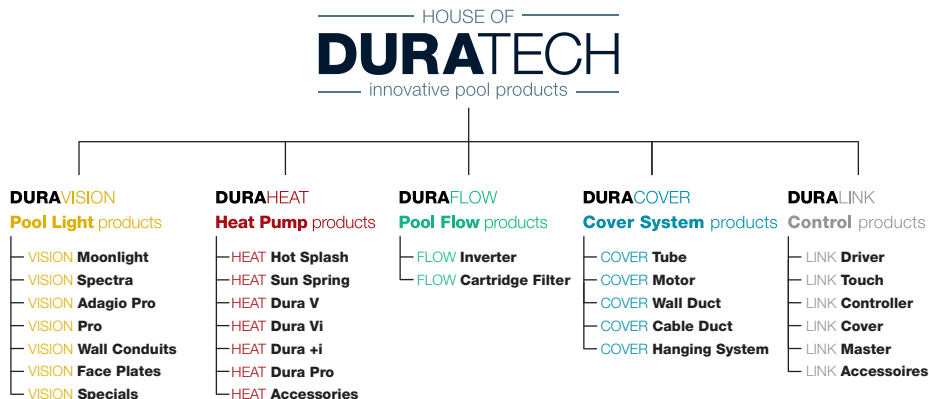

Contact details



Propulsion Systems bv
Dooren 72
1785 Merchtem, Belgium

Tel +32 2 461 02 53

www.duratech.be
info@propulsionsystems.be



DURAVISION



We reserve the rights to change all or part of the contents of this document without prior notice