

HOUSE OF

DURATECH

innovative pool products

Manual

welldana®
●●●

DLT10-RGB/TW

(Other languages available online www.duratech.be)



27-06-22

LINK Touch

Table of contents

Technical specifications	Page 3
Box contents	Page 4
About the LinkTouch™	Page 4
Installation instructions	Page 5
Control functions: pool lights	Page 6
Control functions: heat pump & pool cover	Page 7
Advanced control functions: pool lights	Page 8
Display: Status icons	Page 9
Safety information	Page 10-11
First use	Page 11
How to use the Settings Menu	Page 12
Connecting to ...	Page 13
Cover operation settings	Page 14
Buzzer settings	Page 15
Temperature units display setting	Page 16
Aux setting	Page 17
Factory reset	Page 18
Caring for the LinkTouch™	Page 19
Troubleshooting	Page 19
Link Controller compatibility	Page 20
How to upgrade the Link Controller control board	Page 21
Resetting the LinkTouch™	Page 22
Environment / disposal of old equipment	Page 23
Service & warranty	Page 23
Regulatory compliance	Page 23

DURALINK

Technical specifications

General specifications

Input Voltage:	5 V DC 0,5A
Interface:	LoRa 868 MHz USB-C
Ambient Air Temperature:	0°C to +40°C
Humidity	10% to 90% RH - non condensing
Ingress protection rate:	IP20
IEC Protection Class:	Class II 
Size (in mm):	89,5 (Height) 186,5 (Width) 17,5 (Depth)
Weight:	298 g

Box contents

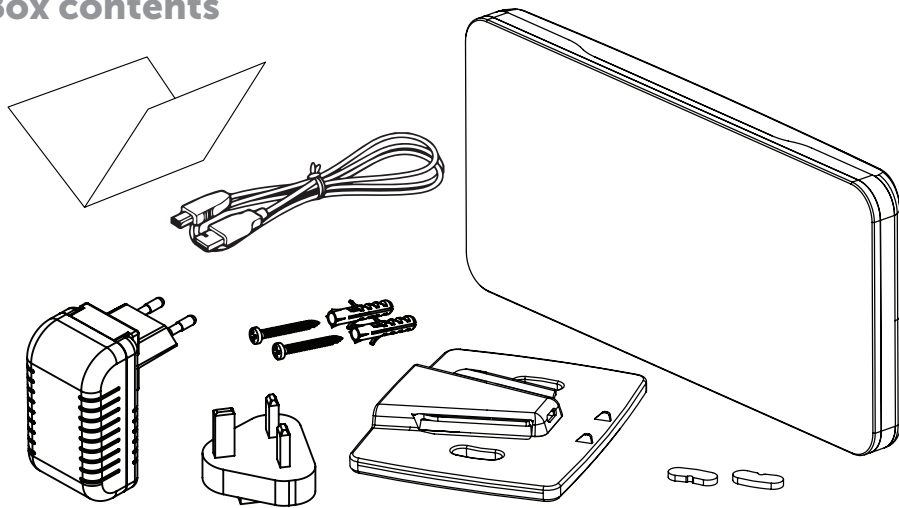

About the LinkTouch™

The LinkTouch™ is the remote of your pool control system. By using the LinkTouch, you can control the lights, the heat pump and cover of your swimming pool. The LinkTouch™ includes an integrated Li-Ion battery which can be charged automatically when mounted onto the wall mount.

The LinkTouch™ connects wirelessly with a compatible Link Driver, Link Controller, Link Master and with DURA-V, DURA-Vi and DURAPRO heat pumps. Please check our website for latest information regarding compatibility with heat pumps

The LinkTouch™ can operate in different modes:

- When the LinkTouch™ is inserted in the Wall Mount, it will charge till full battery.
- When LinkTouch™ is removed from the Wall Mount, it will work instantly when touched.
- When the LinkTouch™ is removed from the Wall Mount and it is not touched for 15 seconds, it will turn into "Standby mode". In this case the display will be off. As soon as the touch panel is touched by the user, the display will turn on again.
- When the battery is empty, the LinkTouch™ will no longer function. To turn on the LinkTouch™ again, it needs to be inserted into the powered wall mount. When inserted the display will be active again and the LinkTouch™ will start communicating with the external devices.

Installation instructions

The LinkTouch™ is powered using the included AC power adapter and USB power cord

1. Plug the USB power cord into the power adapter
2. Plug the other end of the USB power cord into the USB-C connector of the wall mount.
3. Plug the power adapter in a power outlet.
4. Mount the Link Touch onto the wall mount.

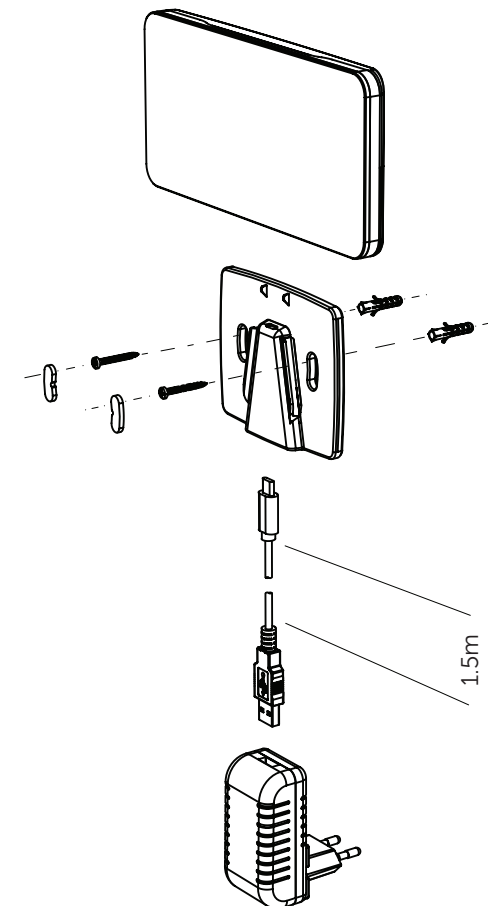

Control functions: pool lights

Colour temperature:

Slide to the right to adjust the pool light from "warm white" to "cool white"

ON/OFF Lights:

Press to switch all Lights ON/OFF

Colour wheel:

Slide to change colour of Pool Lights (only DLT10-RGB)

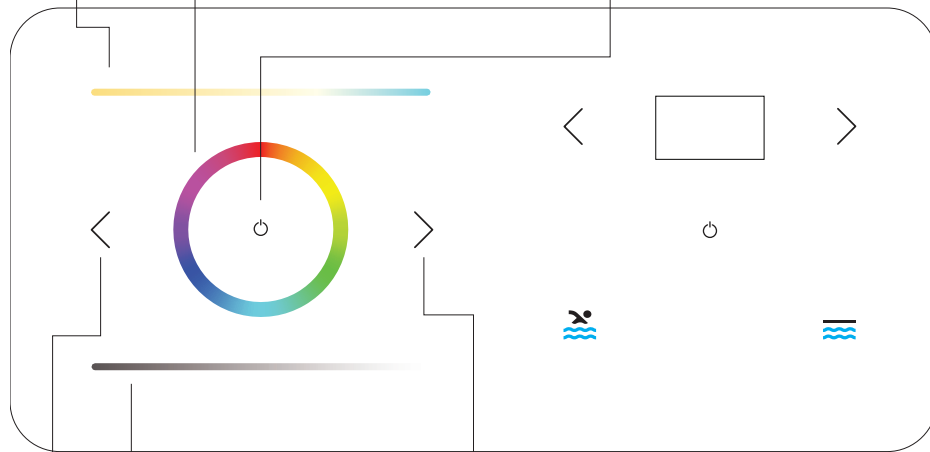

Colour program:

Press for next colour program.

Dimming level:

Slide to the right to increase the brightness of the Pool Lights

Colour program:

Press for previous colour program.

Control functions: heat pump & pool cover

Pool water Temperature DOWN:

Press to decrease desired temperature

Pool water Temperature UP:

Press to increase desired temperature

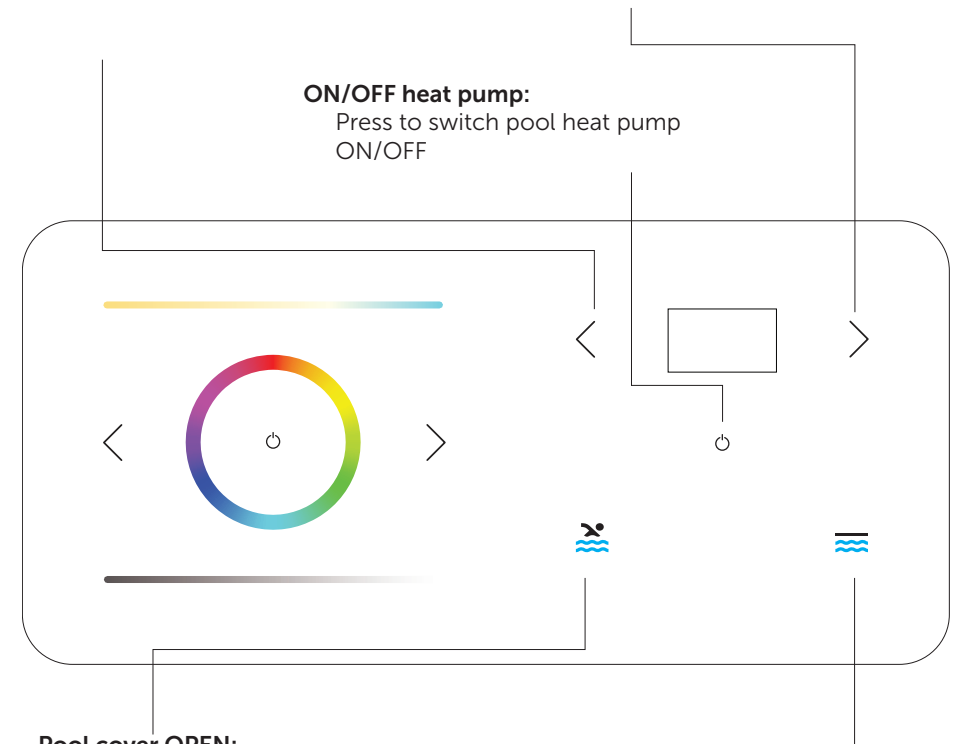

ON/OFF heat pump:

Press to switch pool heat pump ON/OFF

Pool cover OPEN:

IN DMS MODE: Press and hold to open te pool cover. When finger is removed from button the cover will stop immediately.

NOT IN DMS MODE: Press once after calibration and cover fully opens.

Pool cover CLOSE:

IN DMS MODE: Press and hold to close te pool cover. When finger is removed from button the cover will stop immediately.

NOT IN DMS MODE: Press once after calibration and cover fully closes.

NOTE:

Depending on AUX MODE, in settings COVER OPEN/CLOSE or FUNC A/B.

*Depends on DMS mode, when AUX is set to cover.

Advanced control functions: pool lights

Activate the settings menu (*), then use left the left arrow key to return to the previous settings menu.

Activate the settings menu (*), then use right arrow key to select the desired setting.

(*) Touch the display for 3 seconds to activate the settings menu.

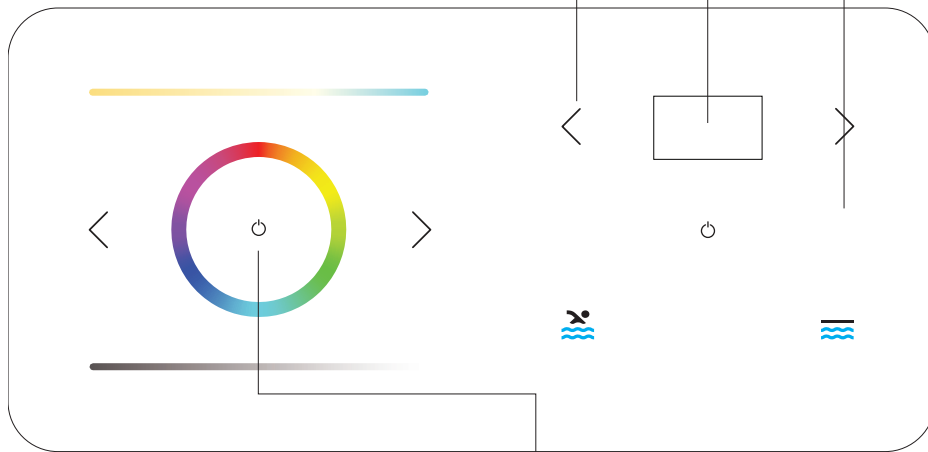

ON/OFF Lights:

Press and hold for 1 second ON/OFF to see the current settings.

How to use the Settings Menu

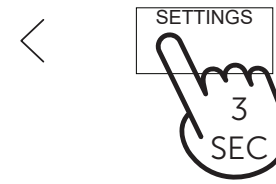

Touch the display on the LinkTouch™ for 3 seconds to go into the settings menu.

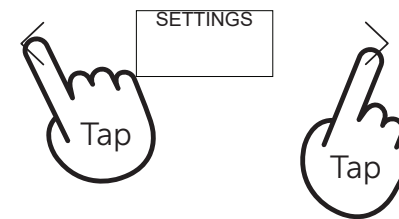

Use arrow keys to select the desired setting.
Right: Next setting
Left: To parent menu

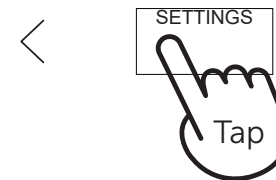

Touch the display once to confirm the setting.

Display: Status icons

Battery:



Battery capacity

Battery is charging

Battery error (p.19)

Signal:



LinkTouch™ is communicating wirelessly

Heat pump:



Pool heat pump is ON (idle)

Pool heat pump is ON and heating/cooling

Pool heat pump has an error (p.19)

Pool lights:

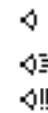

Pool lights are connected

Pool lights are ON

There is an error with the pool lights (p.19)

Relays A and B:



Relays A and B used, not the pool cover function

There is an error with relays A and B (p.19)

Pool cover:



Pool cover is opening/closing

Pool cover is closed

Pool cover is open

There is an error with the pool cover (p.19)

Safety information

Intended use

This device has been developed as a remote control for swimming pool accessories. The LinkTouch™ should be used only for this purpose, as described in this user guide.

Precautions for Setup

- The LinkTouch™ can only be mounted indoor. Do not mount outdoors.
- The power adapter is designed for 100 - 240V, 50/60 Hz. Verify if the power outlet voltage is within this range before plugging in your power adapter.
- Install the device close to an accessible power outlet. Make sure the power/USB cable can be easily disconnected from the power outlet at all times.
- Protect the power/USB cable and the power adapter from being strained pinched or bucked.
- Place the power/USB cable out of walk ways to prevent tripping over the cable.
- Use only the power adapter provided with the LinkTouch™. Use of an incorrect power adapter may cause overheating or fire.
- Do not bend or place a heavy object on the power/USB cable as it could damage the cable and result in risk of electric shock or fire.
- Do not use the power/USB cable if damaged or frayed.
- Be sure to hold only the connector end of the power/USB cable when disconnecting. Repeated pulling on the cable will damage the cable.

Precautions for Operation

- Protect the LinkTouch™ from moisture and do not operate if power/USB cable or plug are defective.
- Never touch a power plug with wet hands.
- Do not place anything on top of the LinkTouch™.
- Never spill liquid of any kind on the LinkTouch™.
- Do not drop or hit the LinkTouch™.

Connecting to ...

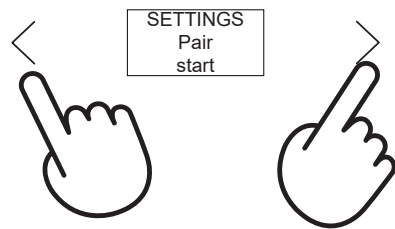

Select "Pair Start"-mode from the settings menu.

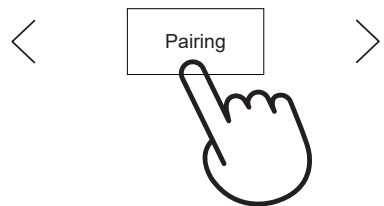

Touch the screen once to put the LinkTouch™ in pairing mode.

This "Pairing"-mode will allow the LinkTouch™ to establish a wireless connection with other devices such as :

- Link Controllers, Link Master, linking per functionality (lights, cover)
- The heat pump

Note : In case the Link Master is already linked with cover and lights and heat pump, it will distribute the links to the LinkTouch™ automatically.

Make sure the LinkTouch™ is in close proximity (<2m) of the device which you would like to pair with wirelessly. Select "Pair Start" on the LinkTouch™. Power on the device.

The device will be in pairing mode for about 2 minutes after switched on. The LinkTouch™ will now be pairing with the device.

Cover operation settings

There are 2 modes:

Deadman switch operation enabled:

The cover operation will run when pressing and holding the finger on the button and will stop when releasing the finger from the button.

Deadman switch operation disabled:

The cover operation will run with a single touch of the button and will stop when touching the button again.

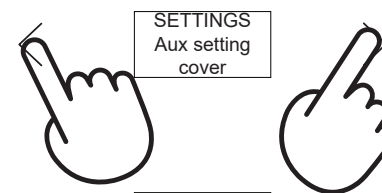

Go to "AUX SETTING" in the settings menu.

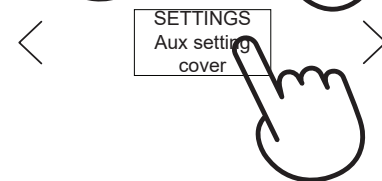

Touch the screen and select "COVER".

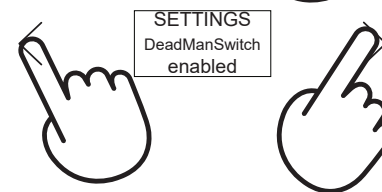

Go to "DEADMANSWITCH" in the settings. Touch the screen to select "DEADMANSWITCH ENABLED".

Warning :

For safety reasons :

1. The cover can only be operated when the remote device is connected to the wall mount in case the "Deadman switch" operation mode is enabled.
2. The wall mount should be installed in close proximity of the pool to make sure that when operating the cover with the remote device, the pool is always in sight of the operator. Note that the wall mount can only be mounted indoors. Do not mount outdoors.
3. The operator must ensure that the path for the cover is clear and nobody gets injured, while operating the cover. Note that Propulsion systems cannot be held responsible for any damage or injury during the operation of the cover.

Note that Propulsion systems cannot be held responsible for any damage or injury during the operation of the cover.

FW V2.1 Cover Calibration in combination with DLM or DLC-010

< SETTINGS
Cover settings
enter



Go to "Cover settings enter" in the settings menu touch screen to enter

< SETTINGS
Cover calibr
start



Touch the screen and select "COVER CALIBRATION START".

< COVER CALIBRATION
DIRECTION
FORWARD



Press the cover close icon on the Link Touch for direction forward. Verify if the cover closes when pressing the cover close symbol. If not press the on/off button once "direction forward" will change to "direction reverse" this will change the polarity. Press the right arrow to confirm and go to the next setting.

< COVER CALIBRATION
POSITION
OPEN



Press the cover open logo on the Link Touch until the cover is fully opened. To confirm and go to the next setting press the right arrow.

< COVER CALIBRATION
POSITION
CLOSE

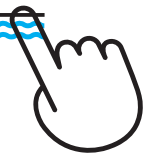

Press the cover close logo until the cover is fully closed. To confirm and go to the next setting press the right arrow.

< COVER CALIBRATION
CONFIRM ?
STORE



Press the on/off icon to confirm the calibration settings



Buzzer settings

The buzzer sound can be set to ON or OFF. If set to ON, then the buzzer will sound each time as confirmation for touching any of the active areas of the LinkTouch™. The beep will also sound when the House of Duratech's DuraCover is in operation. In case of a third party cover, the beeping sound will not be active.

< SETTINGS
Buzzer
Enabled



Go to "BUZZER" in the settings menu.

< SETTINGS
Buzzer
Enabled

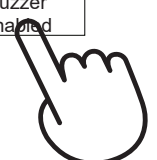

Touch the screen to select the required operation mode. (note that default setting is set to "BUZZER ENABLED".

Warning :

It is advised to set the buzzer setting to "ON", in order to have an audio feedback during the operation of the cover.

Temperature units display setting

The temperature units on the display can be set to Celsius or Fahrenheit

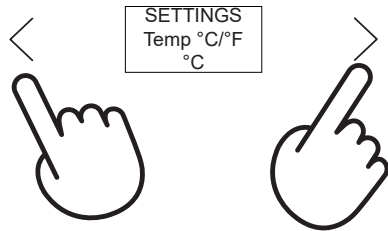

Go to "TEMP °C/°F" in the settings menu.

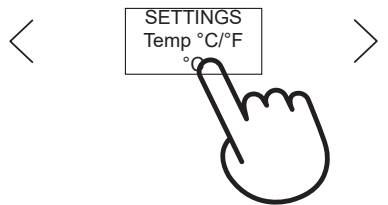

Touch the screen to select the required units. (note that default setting is set to "°C".

Aux setting

This setting will allow the installer to change the cover function to an ON/OFF function for a different device.

The "Aux Setting" can be set to "Cover" or "Auxiliary".

If set to "Cover" then the LinkTouch™ is considered to control a cover system.

If set to "Auxiliary" then the LinkTouch™ will control a different device with the cover buttons and the buttons will act as an "ON" and "OFF" button.

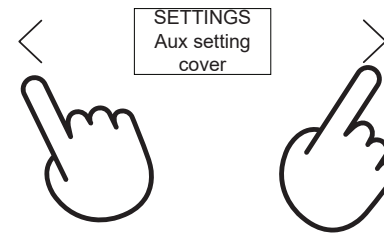

Go to "AUX SETTING" in the settings menu.

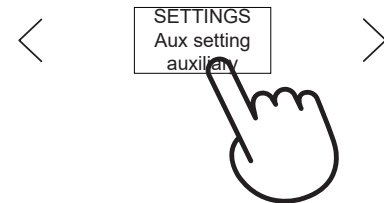

Touch the screen to select "AUX SETTING AUXILIARY".

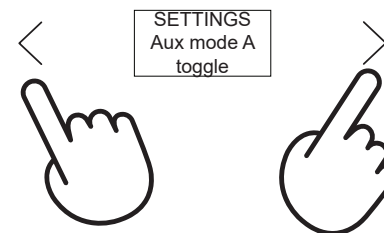

Go to "AUX MODE A" in the settings menu.

Touch the screen to select the required mode "TOGGLE" or "PULSE".

NOTE:
Repeat for "AUX MODE B"

Resetting the LinkTouch™

You can reset (=reboot) the LinkTouch™ without losing the preferred settings.

To reset the Link touch:

Press the "Reset" button on the back of the LinkTouch™, using a paperclip.

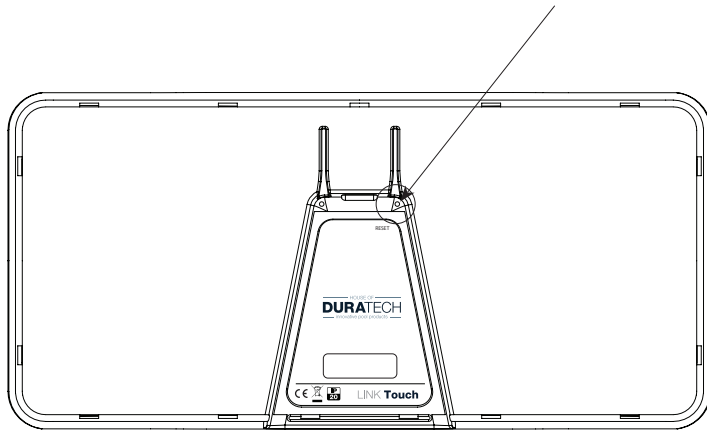

Factory reset

You can reset the LinkTouch™ to the factory default settings. Resetting the LinkTouch™ reverts all settings to the factory default settings. Any settings, including wireless connections, that have been changed are lost.

The factory reset can be found in the setting menu.

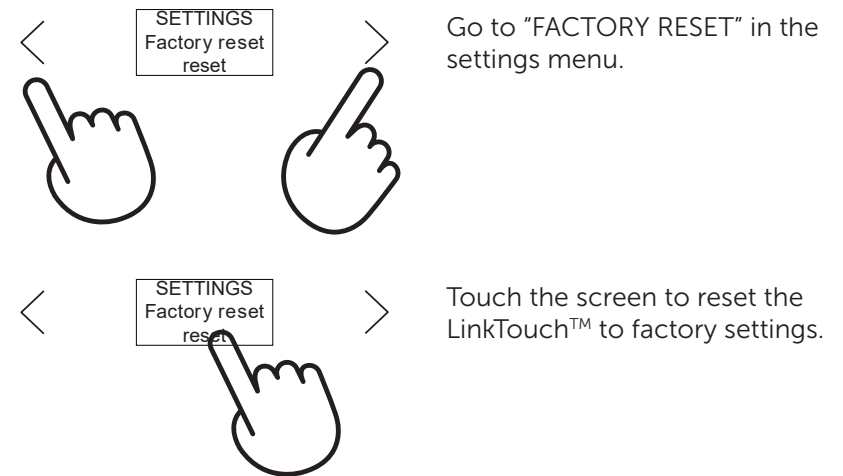

Caring for the LinkTouch™

The LinkTouch™ requires very little maintenance





- You may occasionally need to clean the exterior of the housing.
To clean the exterior of the LinkTouch™, wipe the exterior with a soft, damp cloth.

NOTE: Do not use cleaning tissues or chemical substances which might damage the surface

- Don't place the LinkTouch™ in direct sunlight

Troubleshooting

This section includes information about what to do if you encounter a problem with your LinkTouch™. If you need further assistance, please contact your installer or distributor or go to the support section of the House of Duratech website at www.duratech.be/duracare

-  Battery error
remove from heat source or take out of sunlight
-  Heat pump error
consult manual of heat pump for trouble shooting
-  Pool light error
consult manual of pool light for trouble shooting
-  Aux error
consult manual of auxiliary connected device for trouble shooting
-  Cover error
consult manual of cover for trouble shooting

Link Controller compatibility

To control the lights and the cover system, the LinkTouch™ communicates with the Link Controllers.

If your Link Controller has the sticker "LinkTouch™ ready", then you do not need to take any action. In this case the LinkTouch™ can work with the Link Controller.

In case the Link Controller does not have a "LinkTouch™ ready" sticker, then your Link Controller-requires a firmware update.

See below picture of the control boards of the Link Controller, which are upgradable with an SD card, that is included in the packaging of the LinkTouch™.

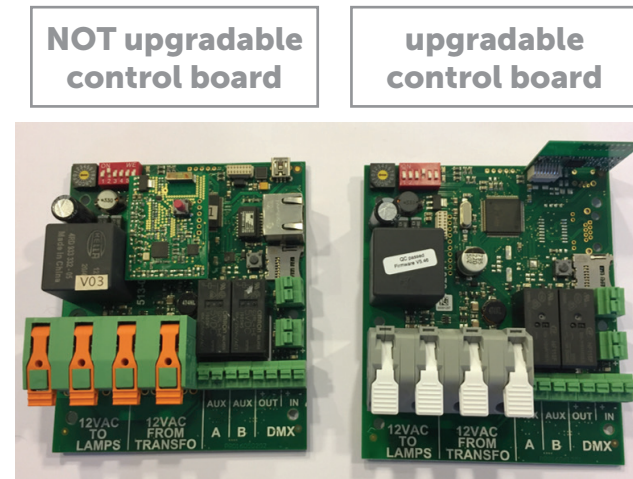

After the firmware upgrade of the Link Controller, the handheld remote control is no longer compatible with the Link Controller. In case a compatible handheld remote control is required, then this one can be ordered separately.



How to upgrade the Link Controller control board

To upgrade the Link Controller, the following steps need to be taken:

1. Switch of the power of the Link Controller.
2. Remove the Lora module from the control board.
3. Insert the SD card into the SD Card slot on the control board.
4. Power up the Link Controller
5. The green LED will be lit and the blue led will start flashing.
6. When the green and blue led remain solid, the firmware has been upgraded.
7. Power down the Link Controller.
8. Remove SD card from SD card slot.
9. Insert the Lora module again.
10. Power up the Link Controller.
11. The Link Controller is now LinkTouch™ compatible.

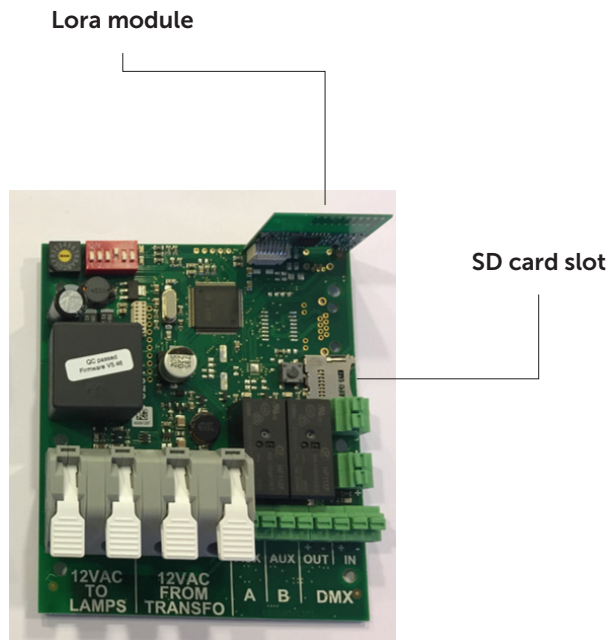

Safety information

Precautions for Cleaning, Transport and Storage

- Use a soft, damp cloth to clean the exterior of the LinkTouch™. Do not use cleaning tissues or chemical substances which might damage the surface.
- This LinkTouch™ contains no user serviceable parts. Do not attempt to service the LinkTouch™ yourself. Repair service should be performed by a authorised technician.



Do NOT drop the LinkTouch™



The LinkTouch™ is NOT water proof

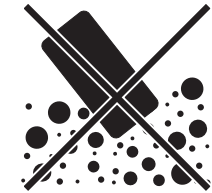

The LinkTouch™ is NOT dust proof

First use

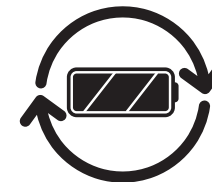

Fully charge the LinkTouch™ before using the device

Environment / Disposal of old equipment

This symbol of a crossed out waste bin on a product, its packaging and/or accompanying documents means that the product is subject to the European Directive 2002/96/EC as well as national law for implementation of the directive. Directive and law prescribe that electrical and electronic products must not be disposed of with household waste. The customer must dispose of the product by delivering it to a designated station for collection, treatment and recycling of waste electrical and electronic equipment. The correct disposal of your old appliance is free of charge and will help prevent potential negative consequences of the environment and human health.

For more information about disposing your old appliance, contact your city office, waste disposal service, or the shop where you purchased the product.



Service & warranty

If you need service or information or if you have a problem, please contact your local dealer. If needed they will contact the manufacturer to solve your problem.

They are gladly willing to assist you!

You can find more information at www.duratech.eu

We warrant all parts to be free from manufacturing defects in materials and workmanship for a period of two years from the date of retail purchase.

This warranty is limited to the first retail purchaser and is not transferable. The liability of the manufacturer shall not exceed the repair or replacement of defective parts and does not include any costs for labour to remove and reinstall the defective part, transportation to or from the factory, and any other materials required to make the repair. This warranty does not cover failures or malfunctions resulting from the following:

1. Failure to properly install, operate or maintain the Link Touch in accordance with the installation guidelines provided in this manual.
2. The workmanship of any installer of the product.
3. Abuse, alteration, accident, fire, flood, lighting, rodents, insects, negligence or acts of god.
4. Use of non-factory authorized parts or accessories in conjunction with the product.

LIMITATION OF LIABILITY

This is the only warranty given by the manufacturer, No one is authorized to make any other warranties on our behalf. This warranty is in lieu of all other warranties, expressed or implied, including but not limited to any implied warranty of fitness for a particular purpose and merchantability. We expressly disclaim and exclude any liability for consequential, incidental, indirect or punitive damages for breach of any expressed or implied warranty. This warranty gives you specific legal rights, which may vary, by country.

WARRANTY CLAIMS

For prompt warranty consideration, contact your dealer and provide the following information: proof of purchase, model number, serial number and date of installation. The dealer will contact the manufacturer for instructions regarding the claim and determine the location of the nearest service point.

Declaration of Conformity

Declarations of conformity covering this product are available for download from the House of Duratech website: www.duratech.be

HOUSE OF DURATECH

innovative pool products

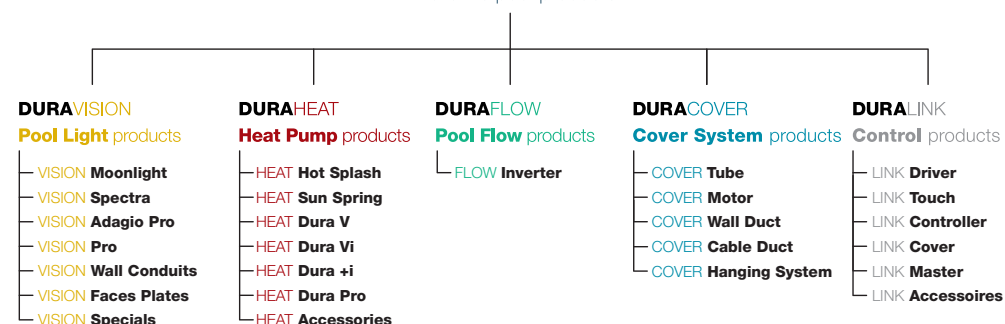



Contact details

Propulsion Systems bv
Dooren 72
1785 Merchtem, Belgium

Tel +32 2 461 02 53

www.duratech.be
info@propulsionsystems.be



DURALINK



We reserve the rights to change all or part of the contents of this document without prior notice