

# ***FULL INVERTER R32***

**SWIMMING POOL HEAT PUMP UNIT**

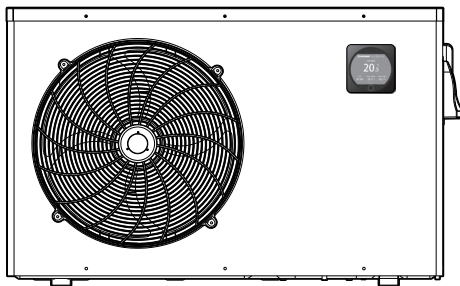

**Installation & Instruction Manual**

# CONTENTS

---

<b>1. PREFACE</b>	<b>1</b>
<b>2. Technical Specifications</b>	<b>4</b>
2.1 Heat pump technical data	4
2.2 Operating range	5
2.3 Dimensions	6
<b>3. INSTALLATION AND CONNECTION</b>	<b>7</b>
3.1 Functional Diagram	7
3.2 Heat pump unit	7
3.3 Hydraulic connection	8
3.4 Electrical connection	9
3.5 Initial start-up	10
3.6 Water flow setting	12
<b>4. USER INTERFACE</b>	<b>13</b>
4.1 General presentation	13
4.2 Timer function settings	15
4.3 Setting the On/Off timers	16
4.4 Adjust setpoint	18
4.5 Locking and unlocking the touch screen	19
4.6 SILENT function settings	20
<b>5. MAINTENANCE AND WINTERISING</b>	<b>23</b>
5.1 Maintenance	23
5.2 Winterising	23
<b>6. APPENDIX</b>	<b>24</b>
6.1 Electrical diagrams	24
6.2 Heating priority wiring for monophasic pump	26
6.3 Exploded view and spare parts / Addendum	28
6.4 Troubleshooting guide	32
6.5 Warranty	35

Please read attentively and save for future consultation.

This document must be given to the pool owner and should be kept in a safe place.

# 1. PREFACE

---

Thank you for purchasing the Hayward heat pump for swimming pools. The Hayward FULL INVERTER heat pump has been designed to strict manufacturing standards meeting the highest levels of quality required.

Hayward heat pumps offer you exceptional performance throughout your bathing season by adapting wattage, power usage and noise levels to the heating requirements of your swimming pool thanks to FULL INVERTER control logic.



***Read the instructions in this manual carefully before using the device.***

Hayward heat pumps are designed exclusively to heat swimming pool water; do not use this equipment for any other purpose.

This manual includes all the necessary information for installation, trouble-shooting and maintenance.

Read this manual carefully before opening the unit or doing any maintenance work on it. The manufacturer of this product shall on no account accept any liability for injury to a user or damage to the unit further to any errors made during installation, trouble-shooting or unnecessary maintenance. It is particularly important to follow the instructions given in this manual at all times.

Otherwise the guarantee will be voided.

# 1. PREFACE (continued)

---



## Safety instructions



***This device contains R32.***

***Never use a refrigerant other than R32. Any other gaseous body mixed with R32 could cause abnormally high pressure and lead to a failure or pipes bursting and injuring people.***

***When carrying out repairs or maintenance work, never use copper tubes less than 0.8 mm thick.***

***As the heat pump is pressurized, never pierce the pipes or attempt any brazing. There is a risk of explosion.***

***Never expose the device to flames, sparks or other sources of ignition. It could explode and cause serious or even fatal injuries.***

- If kept in storage, the heat pump should be kept in a well-ventilated room with a floor area of more than  $A_{\min}$  (m<sup>2</sup>) as calculated by the following formula:  
$$A_{\min} = (M / (2.5 \times 0.22759 \times h_0))^2$$
  
M is the quantity of refrigerant in the device in kg, and h<sub>0</sub> is the storage height. If stored on the floor, h<sub>0</sub> = 0.6 m.
- The heat pump is designed exclusively for installation outside buildings.
- The unit must be installed by qualified personnel.
- Do not install the heat pump on a support that risks intensifying the unit's vibrations.
- Make sure the support provided for the unit is strong enough to bear the weight of the unit.
- Do not install the heat pump anywhere liable to amplify its noise level or anywhere where its noise could disturb neighbours.
- All the electrical connections must be fitted by a professional qualified electrician in accordance with the standards in force in the country of installation, see §3.4.
- Shut off the main power supply and disconnecting switch before doing any electrical work. Forgetting to do so could cause electrocution.
- Before installing the unit, check that the earth cable is not cut or disconnected.

# 1. PREFACE (continued)

---

- Connect and properly tighten the power cable. A loose connection could damage electrical components.
- Exposing the heat pump to water or a humid atmosphere could cause electrocution. Be very careful.
- If you detect a fault or any abnormal situation, do not install the heat pump and contact your dealer immediately.
- All maintenance work should be done at the recommended intervals, as specified in this manual.
- Repairs must be carried out by qualified personnel.
- Only use OEM spare parts.
- Never use a cleaning method other than the one recommended in this manual.

## Important information concerning the refrigerant used

This makes contains fluorinated greenhouse gases regulated by the Kyoto protocol. Do not release these gases into the atmosphere.

Type of refrigerant: R32

GWP(1) value: 675, based in the 4th report of the IPCC.

The quantity of refrigerant, based on the F-Gas regulation no. 517/2014, is stated on the unit's rating plate.

Period checks for leaks of refrigerant may be required by European or local legislation. Please contact your local dealer for more information.

(1) Global warming potential

## 2. TECHNICAL SPECIFICATIONS

### 2.1 Heat pump technical data

Models	CLASSIC FULL INVERTER	ECLI15MA(*)	ECLI20MA(*)	ECLI30MA(*)	ECLI40MA(*)
Supply voltage	V	220V-240V ~/1ph/50Hz			
Refrigerant	/	R32			
Load	kg	0.350	0.430	0.480	0.650
Mass in teqCO <sub>2</sub>	/	0.24	0.29	0.32	0.44
Leak check frequency	/	No specific frequency, but an annual check is recommended			
Min--Max heating capacity <sup>(a)</sup>	kW	1.62--7.33	2.18--8.97	1.97--11.66	2.85--17.06
Min--Max electric input power <sup>(a)</sup>	kW	0.15--1.17	0.17--1.54	0.16--1.99	0.26--3.13
Min--Max continuous current rating <sup>(a)</sup>	A	1.15--5.32	1.27--6.91	1.08--8.96	1.41--13.69
Max--Min continuous power (COP) (a)	/	11.04--6.30	12.77--5.81	12.57--5.84	11.08--5.45
Min--Max heating capacity <sup>(b)</sup>	kW	1.44--5.36	1.58--6.94	1.79--8.62	2.74--13.08
Min--Max electric input power <sup>(b)</sup>	kW	0.24--1.14	0.27--1.53	0.290--1.90	0.428--2.97
Max--Min continuous power (COP) <sup>(b)</sup>	/	5.98--4.69	5.82--4.53	6.17--4.52	6.40--4.40
Maximum continuous current	A	6.4	8.4	10.9	16.6
Fuse rating	aM	8	10	16	20
Circuit-breaker curve D	D	8	10	16	20
Starting current	A	< maximum continuous current			
Hydraulic connection	mm	50 mm			
Nominal water flow (a)	m <sup>3</sup> /h	3.10	3.80	4.90	7.30
Max. loss of head on water	kPa	2.3	2.9	6.4	6.7
Compressor	/	Mitsubishi DC Inverter			Highly DC Inverter
Type	/	Twin rotary			Twin rotary
Quantity	/	1			
Coil resistance at 20°C	Ohm	1.91			0.788
Fan	/	Axial			
Quantity	/	1			
Diameter	mm	405			510
Number of blades	/	3			
Motor	/	DC Inverter			
Quantity	/	1			
Rotation speed	rpm	600--700	600--800	850--950	600--850
Silent mode speed	rpm	400	400	400	300
Sound pressure level at 1 metre	dB(A)	35	43	43	46
Sound pressure level at 10 metres	dB(A)	18	25	25	29
Unit's net dimensions (L-W-H)	mm	1040/425/615			1130/460/780
Weight	kg	42	45	46	60

(\*) Check the machine references on the conversion table (see label on the cover of the manual).

(a) Dry air 27°C - Relative humidity 78% - Water inlet temperature 26°C.



(b) Dry air 15°C - Relative humidity 71% - Water inlet temperature 26°C

## 2. TECHNICAL SPECIFICATIONS (continued)

---

### 2.2 Operating range

Use the swimming pool heat pump unit within the following ranges of temperature and humidity to ensure safe and efficient operation.

	Heating mode 	Cooling mode 
Outside temperature	-7°C – +35°C	+7°C – +43°C
Water temperature	+12°C – +32°C	+8°C – +40°C
Relative humidity	< 80%	< 80%
Setting range from the set point	+15°C – +32°C	+8°C – +32°C



***If the temperature or humidity does not correspond to these conditions, the security measures could be activated and the swimming pool heat pump unit may no longer work.***



***The maximum heating temperature is set at 32°C to prevent damage to the liners. Hayward cannot be held responsible if used at a temperature above +32°C.***

## 2. TECHNICAL SPECIFICATIONS (continued)

### 2.3 Dimensions

Models:

**ECLI15MA / ECLI20MA / ECLI30MA\***

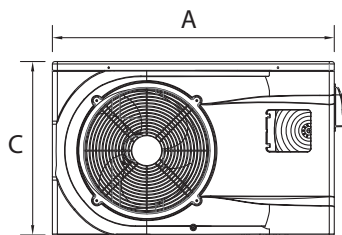
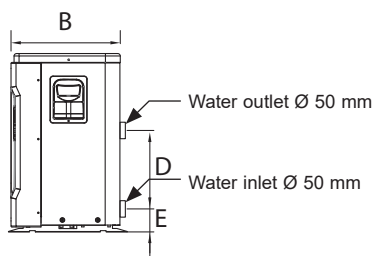

**ECLI40MA\***

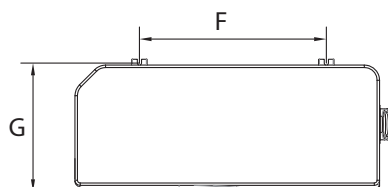
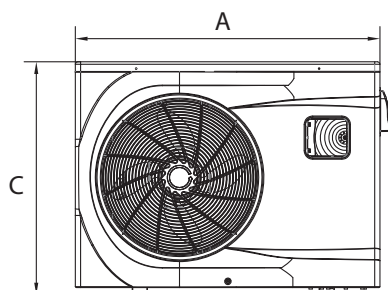
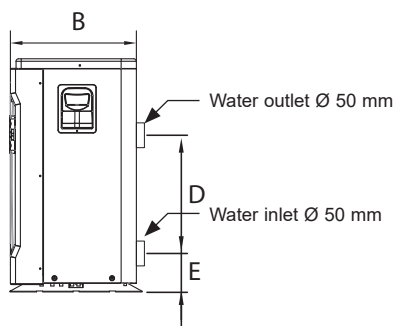

Unit: mm

Size \ Type(*)	ECLI15MA / ECLI20MA / ECLI30MA	ECLI40MA
<b>A</b>	956	1002
<b>B</b>	360	415
<b>C</b>	605	767
<b>D</b>	350	350
<b>E</b>	98	101
<b>F</b>	545	615
<b>G</b>	380	442

(\*) Check the machine references on the conversion table (see label on the cover of the manual).



### 3. INSTALLATION AND CONNECTION

#### 3.1 Functional Diagram

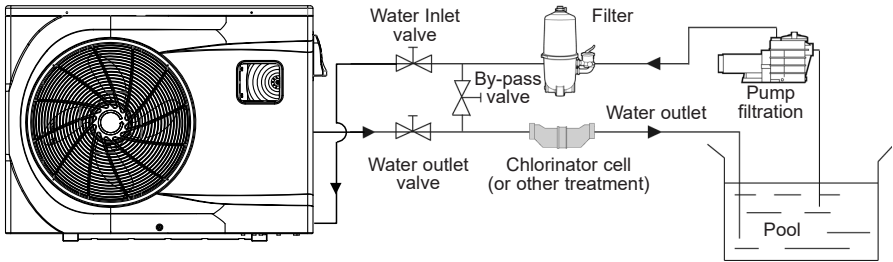

Note : The swimming pool heat pump unit is sold without any treatment or filtration equipment. The components presented in the diagram are spare parts to be supplied by the installer.

#### 3.2 Heat pump unit



***Place the heat pump outdoors and away from any enclosed technical space.***

***Placed under a shelter, the minimum required distances mentioned below must be respected in order to avoid any risk of air recirculation and a deficiency in the unit's overall performance.***

Unit: mm

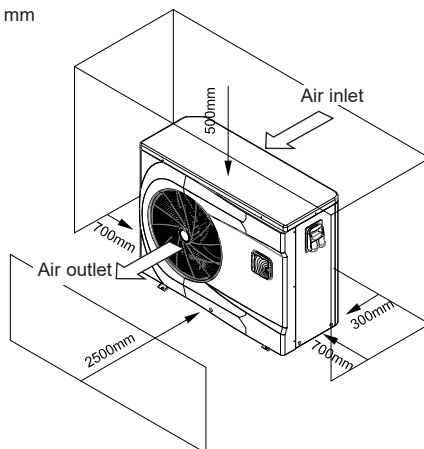

### 3. INSTALLATION AND CONNECTION (continued)

---



*It is advised to install the unit on a dissociated cement block or a mounting bracket designed for this use and to set up the unit on the supplied rubber bushing (fastenings and washers not supplied).*

*The maximum installation distance between the unit and the swimming pool is 15 metres.*

*The total length of the piping to and from the unit is 30 metres.*

*Insulate both the above ground and buried hydraulic piping.*

*The heat pump must be installed at a minimum distance from the pool in compliance with NF C 15-100 (3.5 m from the water for France) or in compliance with installation standards applicable in other countries.*

*Do not install the heat pump close to a heat source.*

*For installation in snowy regions we recommend sheltering the machine to avoid snow accumulating on the evaporator.*

#### 3.3 Hydraulic connection

The unit is supplied with two 50 mm Ø union connections. Connect the water inlet to the heat pump coming from the filtration group then connect the water outlet to the heat pump at the water conduit going to the pool (see diagram below).

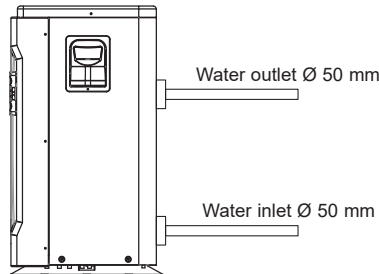

Install a by-pass valve between the heat pump entrance and exit.



*If an automatic distributor or an electrolyser is used, it should be installed imperatively after the heat pump with the goal of protecting the titanium condenser against an elevated concentration of chemicals.*



*Be sure to install the by-pass valve and the supplied union connections at the water inlet and outlet level in order to simplify purging during the winter period and to facilitate access when disassembling for maintenance.*

# 3. INSTALLATION AND CONNECTION (continued)

## 3.4 Electrical connection



**Electrical installation and wiring for this equipment must be in conformity with local installation standards.**

F	NF C15-100	GB	BS7671:1992
D	DIN VDE 0100-702	EW	EVHS-HD 384-7-702
A	ÖVE 8001-4-702	H	MSZ 2364-702/1994/MSZ 10-553 1/1990
E	UNE 20460-7-702 1993, RECBT ITC-BT-31 2002	M	MSA HD 384-7-702.S2
IRL	Wiring Rules + IS HD 384-7-702	PL	PN-IEC 60364-7-702:1999
I	CEI 64-8/7	CZ	CSN 33 2000 7-702
LUX	384-7.702 S2	SK	STN 33 2000-7-702
NL	NEN 1010-7-702	SLO	SIST HD 384-7-702.S2
P	RSIUEE	TR	TS IEC 60364-7-702



**Verify that the available electrical power supply and the network frequency correspond to the required operating current taking into account the appliance's specific location, and the current required to supply any other appliance connected to the same circuit.**

**ECLI15MA / ECLI20MA / ECLI30MA / ECLI40MA(\*)**  
**230V ~ +/- 10 % 50 Hz 1 Phase**

**See the corresponding wiring diagram in the appendix.**  
**The connection box is located on the right side of the unit. Three connections are designed for the power supply and two are for controlling the filter pump (Enslavement).**

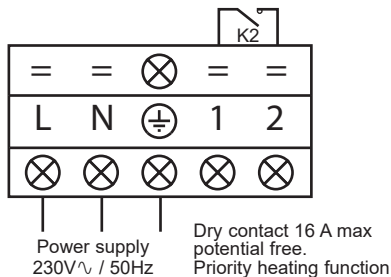

(\*) Check the machine references on the conversion table (see label on the cover of the manual).

### 3. INSTALLATION AND CONNECTION (continued)

---



***The electrical power supply must have, when appropriate, a fuse protection device like a feed motor (aM) or D curve circuit breaker as well as a differential circuit breaker 30mA (see following table).***

Models		ECLI15MA(*)	ECLI20MA(*)	ECLI30MA(*)	ECLI40MA(*)
Power supply	V/Ph/Hz	230V~ 50Hz	230V~ 50Hz	230V~ 50Hz	230V~ 50Hz
aM type fuse calibre	A	8 aM	10 aM	16 aM	20 aM
Curve D circuit breaker	A	8 D	10 D	16 D	20 D
Cable section	mm <sup>2</sup>	3G 2,5	3G 2,5	3G 2,5	3G 4

(\*) Check the machine references on the conversion table (see label on the cover of the manual).



***Use an RO 2V/R 2V or equivalent power cord.***



***The cables sections are given for a maximum length of 25 m. They must however be checked and adjusted according to the installation conditions.***



***Always shut down the main power supply before opening the electrical control box.***

#### 3.5 Initial start-up

Start-up procedure - After installation is complete, follow these steps:

- 1) Rotate the fans by hand to verify that they can turn freely by hand, and that the turbine is correctly affixed to the motor shaft.
- 2) Ensure that the unit is connected correctly to the main power supply (see the wiring diagram in the appendix).
- 3) Activate the filtration pump.
- 4) Verify that all water valves are open and that the water flows toward the unit before switching on the heating or cooling mode.
- 5) Verify that the drainage hose is correctly affixed and that it causes no obstructions.
- 6) Activate the unit power supply, then press the On/Off button  on the control panel.
- 7) Make sure the alarm or lock symbols are not displayed. If need be, see the trouble-shooting guide (see § 6.4).

### 3. INSTALLATION AND CONNECTION (continued)

---

- 8) Set the water flow using the by-pass valve (see § 3.6 and 2.1), as provided for by each model, to obtain an Entry/Exit temperature of 2°C.
- 9) After running for several minutes, verify that the air exiting the unit is cool (between 5 and 10°).
- 10) With the unit operating, turn off the filter pump. The unit should automatically turn off and display error code E03 (See § 6.4).
- 11) Allow the unit and the pool pump to run 24 hours per day until the desired water temperature has been reached. When the set water inlet temperature is reached, the unit will turn off. It will automatically restart (as long as the pool pump is running) if the pool temperature is at least 0.5°C below the set temperature.

**Water flow switch** - The unit is equipped with a flow switch that turns on the heat pump when the pool filtration pump is running, and deactivates it when the filtration pump is out of order. If the water is low, the E03 alarm code will appear on the regulator (See § 6.4).

**Time delay** - The unit is equipped with a time delay of 3 minutes in order to protect the control circuit components, to eliminate restart cycling and contactor chatter. Thanks to this time delay, the unit automatically restarts approximately 3 minutes after each control circuit interruption. Even a brief power interruption will activate the restart time delay.

## 3. INSTALLATION AND CONNECTION (continued)

---

### 3.6 Water flow setting

With the water entry and exit valves being open, adjust the by-pass valve in order to obtain a difference of 2°C between the inflow and outflow temperature (see principle diagram § 3.1). You can verify the switch by seeing the entry/exit temperatures directly on the control panel.



Note: Opening the by-pass valve creates a weaker flow, which leads to an increase in  $\Delta T$ .

Closing the by-pass valve creates a stronger flow, which leads to a decrease in  $\Delta T$ .

# 4. USER INTERFACE

## 4.1 General presentation

The heat pump is equipped with a digital control panel with a touch screen, electronically connected and pre-set at the factory in heating mode.

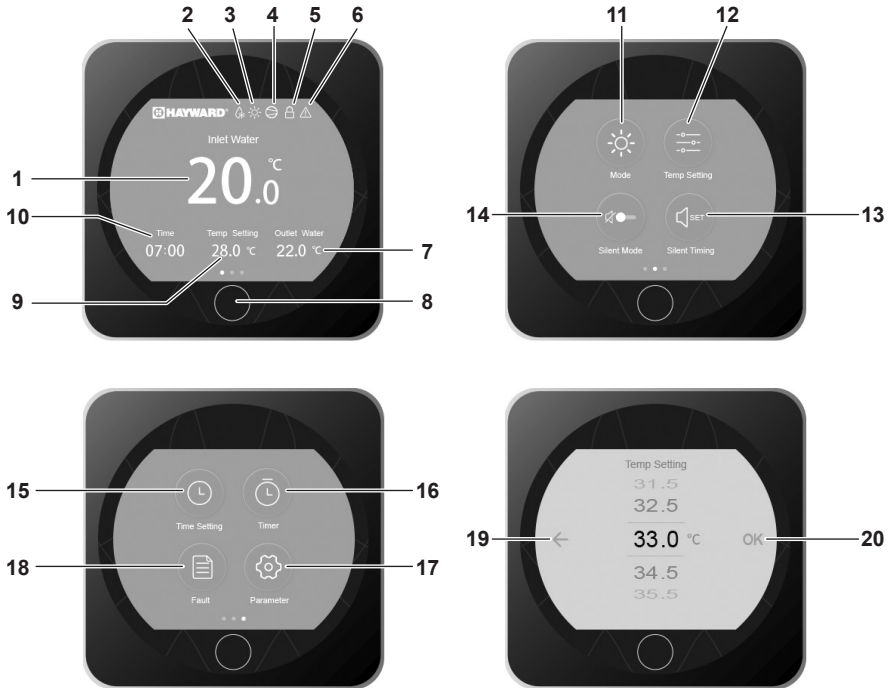

### Legend

1	Water Input temperature
2	Defrost mode
3	Operating mode
4	Compressor's ON indicator
5	Lock screen
6	Alarm
7	Water Output temperature
8	On/Off/Back
9	Setpoint temperature
10	Hour

11	Operating mode selection
12	Adjust setpoint
13	Setting silence mode timer
14	Activate silent mode
15	Set date and time
16	Set On/Off timers
17	Access Advanced Settings
18	Access list of faults
19	Back (changes not confirmed)
20	Confirm

## 4. USER INTERFACE (continued)

---

### OFF mode

When the heat pump is idle (in standby mode), OFF is displayed as shown on the screen.

The black screen indicates that the heat pump is idle; settings can be adjusted in this mode.



### ON mode

When the heat pump is running or priming (setpoint reached), the screen turns blue.



To switch from OFF to ON mode and vice versa, press the  button.



# 4. USER INTERFACE (continued)

## 4.2 Timer function settings

The date and time can be set either in ON or in OFF mode.



- Press 1 times on  to return to the main screen.

## 4. USER INTERFACE (continued)

### 4.3 Setting the On/Off timers

Setting this function is necessary if you would like to run the heat pump for a shorter period than what is defined by the filtration clock. Therefore, you can program a deferred start and an anticipated stop or simply stop a certain timeframe from running (at night, for example).

It is possible to set one Start Timer and one Stop Timer.  
The setting step is "hour to hour".



## 4. USER INTERFACE (continued)

---



**Blue highlighting = Activated**  
**Grey = Deactivated**

- Press 2 times on  to return to the main screen.

## 4. USER INTERFACE (continued)

### 4.4 Adjust setpoint

The setpoint can be changed either in ON or in OFF mode with an accuracy of 0.5°C.



- Press 1 times on  to return to the main screen.



*It is recommended to never exceed 30°C to avoid alteration of the liners.*

## 4. USER INTERFACE (continued)

### 4.5 Locking and unlocking the touch screen

The screen can be locked or unlocked either in ON or in OFF mode.



Lock activated



Lock deactivated

## 4. USER INTERFACE (continued)

---

### 4.6 SILENT function settings

Silence mode enables the heat pump to be used in economic and very silent mode when the heating needs are low (maintaining the pool temperature or need for ultra-silent operation).

This function can be Activated/Deactivated manually or using a Timer.

#### Activation/Deactivation

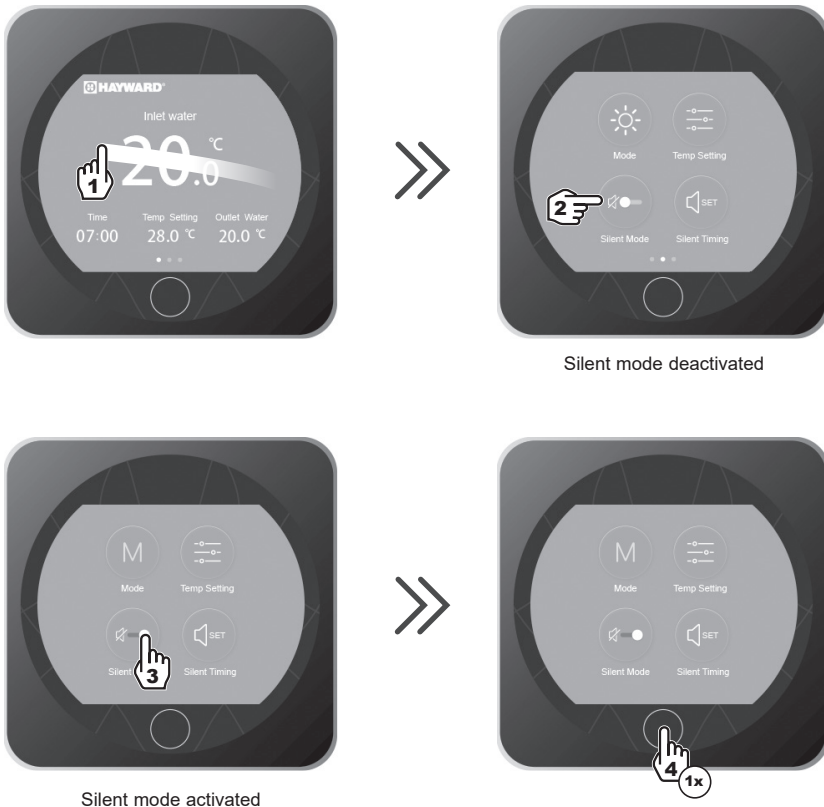

- Press 1 times on  to return to the main screen.

## 4. USER INTERFACE (continued)

---

### Adjusting the SILENT mode Timer



## 4. INTERFACE UTILISATEUR (suite)

---



- Press 2 times on  to return to the main screen.



**The setting step is "hour to hour".  
Once the Timer is activated, it is active 7 days a week.**



## 5. MAINTENANCE AND WINTERISING

---

### 5.1 Maintenance

These maintenance operations must be carried out once per year in order to guarantee the longevity and the good working condition of the heat pump.

- Clean the coil with the help of a soft brush or jet of air or water (**Warning, never use a high pressure cleaner**).
- Verify that the drains flow well.
- Verify the tightening of the hydraulic and electrical connections
- Verify the hydraulic sealing of the condenser.
- Have the leak-tightness of the cooling circuit to the leak detector checked by an **accredited professional**.



***Before any maintenance operation, the heating pump must be disconnected from any electrical current source. The maintenance operations must only be carried out by personnel that is qualified and authorised to handle liquid refrigerants.***

### 5.2 Winterising

- Put the heat pump in “OFF” mode.
- Cut the power supply to the heat pump.
- Empty the condenser with the help of the drain to avoid any risk of deterioration. (high risk of freezing).
- Close the by-pass valve and unscrew the entry/exit connection unions.
- Eliminate the maximum amount of residual stagnant water from the condenser with the help of an air gun.
- Close the water entry and exit areas of the heating pump to avoid introducing foreign bodies.
- Cover the heating pump with a dedicated winterising case.



***Any damage caused by poor winterising maintenance will lead to cancellation of the warranty.***

# 6. APPENDIX

## 6.1 Electrical diagrams

### ECLI15MA / ECLI20MA / ECLI30MA (\*)

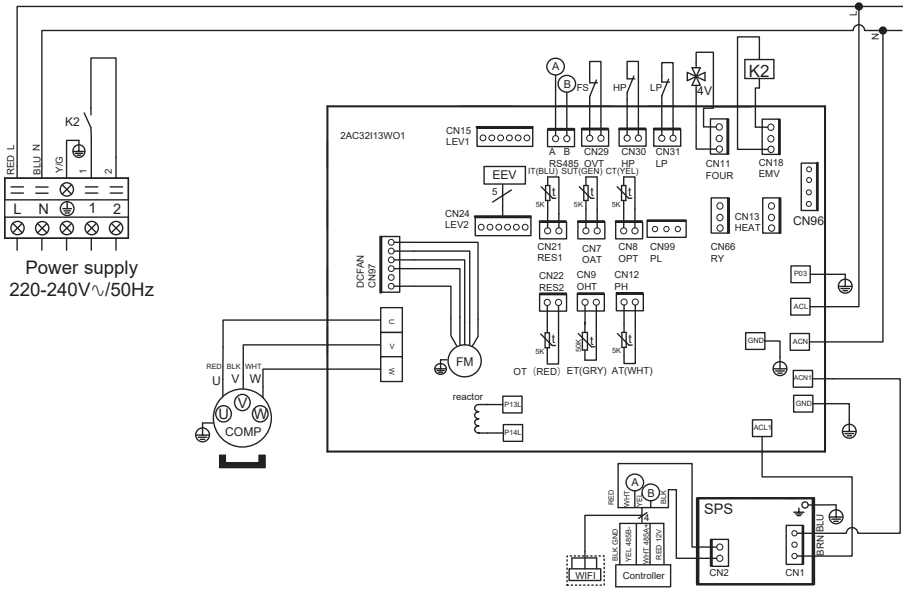

#### REMARKS

- |  |   |
|--|---|
| <b>AT</b> : AIR TEMPERATURE SENSOR         | <b>LP</b> : LOW PRESSURE SWITCH             |
| <b>COMP</b> : COMPRESSOR                   | <b>OT</b> : OUTLET WATER TEMPERATURE SENSOR |
| <b>CT</b> : EVAPORATOR TEMPERATURE SENSOR  | <b>SUT</b> : SUCTION TEMPERATURE SENSOR     |
| <b>EEV</b> : ELECTRONIC EXPANSION VALVE    | <b>4V</b> : 4 WAYS VALVE                    |
| <b>FM</b> : FAN MOTOR                      | <b>K2</b> : DRY CONTACT 16 A MAX            |
| <b>FS</b> : WATER FLOW SWITCH              | <b>ET</b> : DISCHARGE TEMPERATURE SENSOR    |
| <b>HP</b> : HIGH PRESSURE SWITCH           | <b>---</b> : OPTION                         |
| <b>IT</b> : WATER INLET TEMPERATURE SENSOR |   |

(\*) Check the machine references on the conversion table (see label on the cover of the manual).

# 6. APPENDIX (continued)

## ECLI40MA (\*)

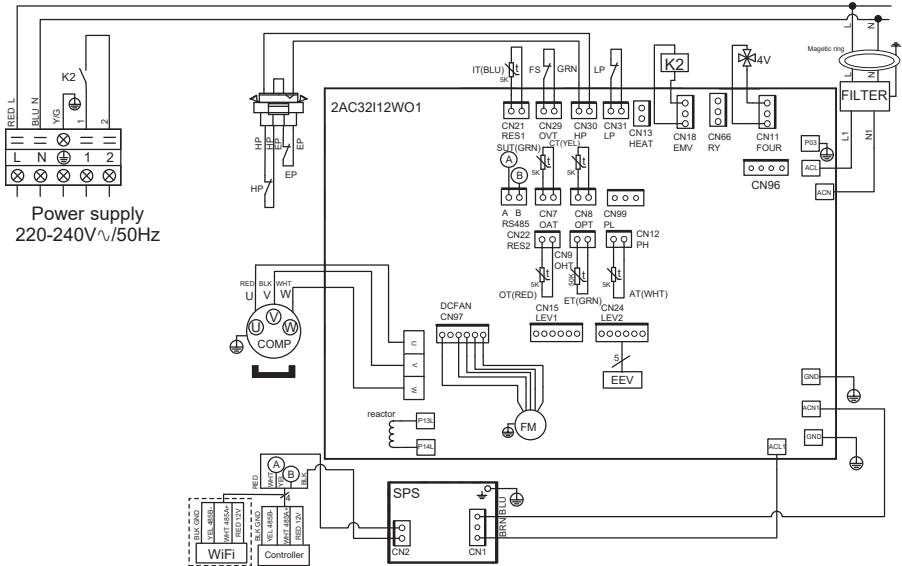

### REMARKS

- |  |   |
|--|---|
| <b>AT</b> : AIR TEMPERATURE SENSOR         | <b>LP</b> : LOW PRESSURE SWITCH             |
| <b>COMP</b> : COMPRESSOR                   | <b>OT</b> : OUTLET WATER TEMPERATURE SENSOR |
| <b>CT</b> : EVAPORATOR TEMPERATURE SENSOR  | <b>SUT</b> : SUCTION TEMPERATURE SENSOR     |
| <b>EEV</b> : ELECTRONIC EXPANSION VALVE    | <b>4V</b> : 4 WAYS VALVE                    |
| <b>FM</b> : FAN MOTOR                      | <b>K2</b> : DRY CONTACT 16 A MAX            |
| <b>FS</b> : WATER FLOW SWITCH              | <b>ET</b> : DISCHARGE TEMPERATURE SENSOR    |
| <b>HP</b> : HIGH PRESSURE SWITCH           | <b>---</b> : OPTION                         |
| <b>IT</b> : WATER INLET TEMPERATURE SENSOR |   |

(\*) Check the machine references on the conversion table (see label on the cover of the manual).

# 6. APPENDIX (continued)

## 6.2 Heating priority wiring for monophasic pump

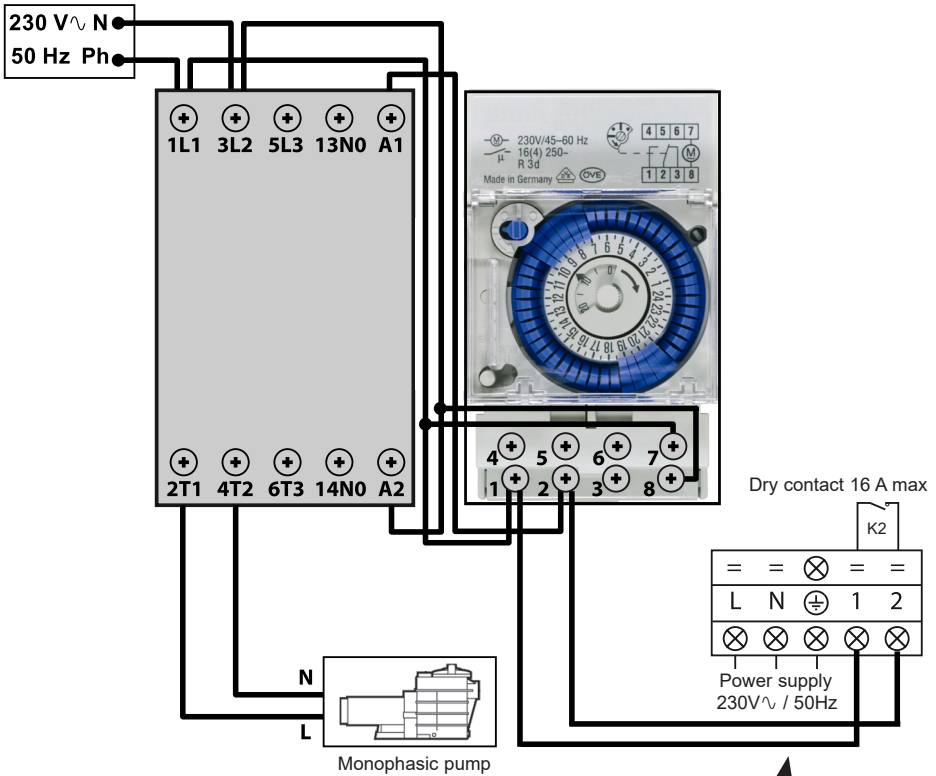

Terminals 1 and 2 deliver a potential-free dry contact, 230V~/ 50 Hz, no polarity.

Wire terminals 1 and 2 as indicated in the diagram above, to activate the operation of the filtration pump in 2-minute cycles each hour if the temperature of the pool is lower than the set point.

**!** Never connect the power supply of the filtration pump directly to terminals 1 and 2.



---

*Page left intentionally blank*

# 6. APPENDIX (continued)

## 6.3 Exploded view and spare parts / Addendum

ECLI15MA / 20MA / 30MA / 40MA (\*)

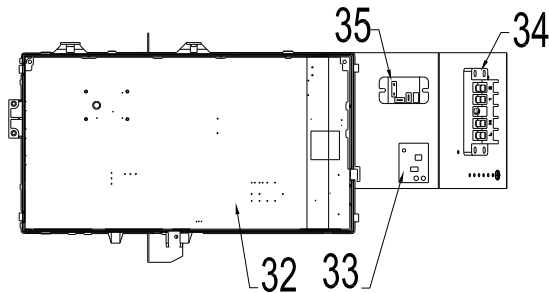
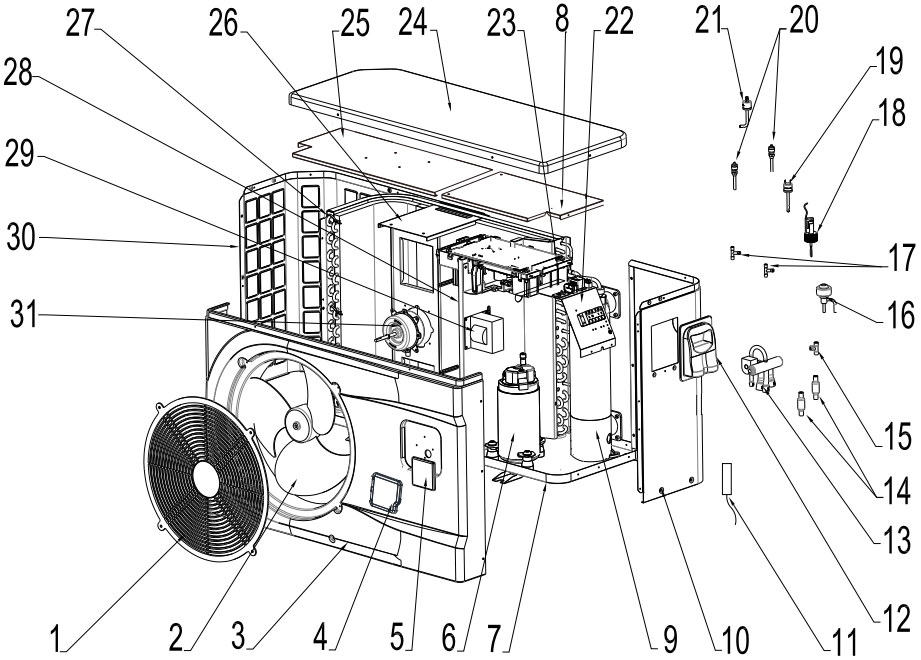

## 6. APPENDIX (continued)

Mark	Description	Ref.	ECLI15MA*	ECLI20MA*	ECLI30MA*	ECLI40MA*
1	Fan protection grille	HWX20000220245	✓	✓	✓	n/a
		HWX20000220369	n/a	n/a	n/a	✓
2	Fan blade	HWX301030000006	✓	✓	✓	n/a
		HWX301030000001	n/a	n/a	n/a	✓
3	Front panel	HWX809000099	✓	✓	✓	n/a
		HWX809001100	n/a	n/a	n/a	✓
4	Smoked Protection cover	HWX809000320	✓	✓	✓	✓
5	LED Controller	HWX82300038	✓	✓	✓	✓
6	Compressor	HWX20000110448	✓	✓	✓	n/a
	Compressor	HWX80100003	n/a	n/a	n/a	✓
7	/	/	/	/	/	/
8	/	/	/	/	/	/
9	Titanium/PVC condenser	HWX80600037	✓	n/a	n/a	n/a
		HWX32012120061	n/a	✓	n/a	n/a
		HWX32012120056	n/a	n/a	✓	n/a
		HWX806000096	n/a	n/a	n/a	✓
10	Right panel	HWX80700445	✓	✓	✓	n/a
		HWX80700314	n/a	n/a	n/a	✓
11	Compressor aspiration sensor 5k-560mm	HWX83000044	✓	✓	✓	n/a
	Compressor aspiration sensor 5k-760mm	HWX83000053	n/a	n/a	n/a	✓
	Ambiente temp sensor 5k-350mm	HWX83000049	✓	✓	✓	✓
	Water outlet sensor 5k-410mm	HWX83000050	✓	✓	✓	✓
	Water inlet sensor 5k-850mm	HWX83000052	✓	✓	✓	✓
	Compressor Discharge probe 50k-660mm	HWX83000026	✓	✓	✓	✓
	De-icing sensor 5k-680mm	HWX83000051	✓	✓	✓	n/a
	De-icing sensor 5k-1040mm	HWX83000045	n/a	n/a	n/a	✓
12	Access hatch	HWX320922029	✓	✓	✓	✓
13	4 ways valve	HWX20041437	✓	✓	✓	✓
14	Filter ø9.7-ø9.7 (Ø19)	HWX20000140178	✓	✓	✓	n/a
	Filter ø9.7-ø9.7 (Ø28)	HWX20041444	n/a	n/a	n/a	✓
15	T connector ø9.52-2 x ø6.35(T) x 1.0	HWX30403000002	✓	✓	✓	✓
16	Electronic expansion valve	HWX20000140570	✓	✓	✓	n/a
		HWX81000013	n/a	n/a	n/a	✓
17	T connector ø6.5-2 x ø6.5(T) x 0.75	HWX20001460	✓	✓	✓	✓
18	Water flow detector	HWX83000012	✓	✓	✓	✓
19	Low pressure switch NO 0.30MPa/0.15MPa	HWX20000360157	✓	✓	✓	✓
20	Pressure Tap 40mm 1/2"	HWX20000140150	✓	✓	✓	✓
21	High pressure switch NC 3.2MPa/4.4MPa	HWX20013605	✓	✓	✓	✓
22	/	/	/	/	/	/
23	/	/	/	/	/	/
24	Top cover	HWX809000055	✓	✓	✓	n/a
		HWX301090200806	n/a	n/a	n/a	✓
25	/	/	/	/	/	/
26	Motor bracket	HWX80700218	✓	✓	✓	n/a
		HWX80700248	n/a	n/a	n/a	✓

(\*) Check the machine references on the conversion table (see label on the cover of the manual).

# 6. APPENDIX (continued)

ECLI15MA / 20MA / 30MA / 40MA (\*)

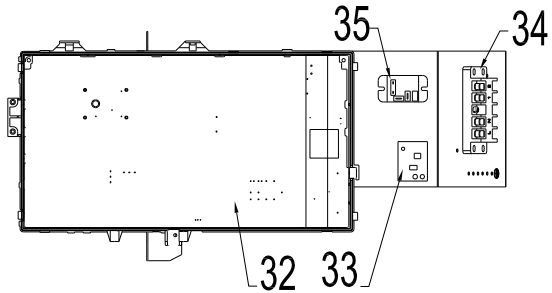
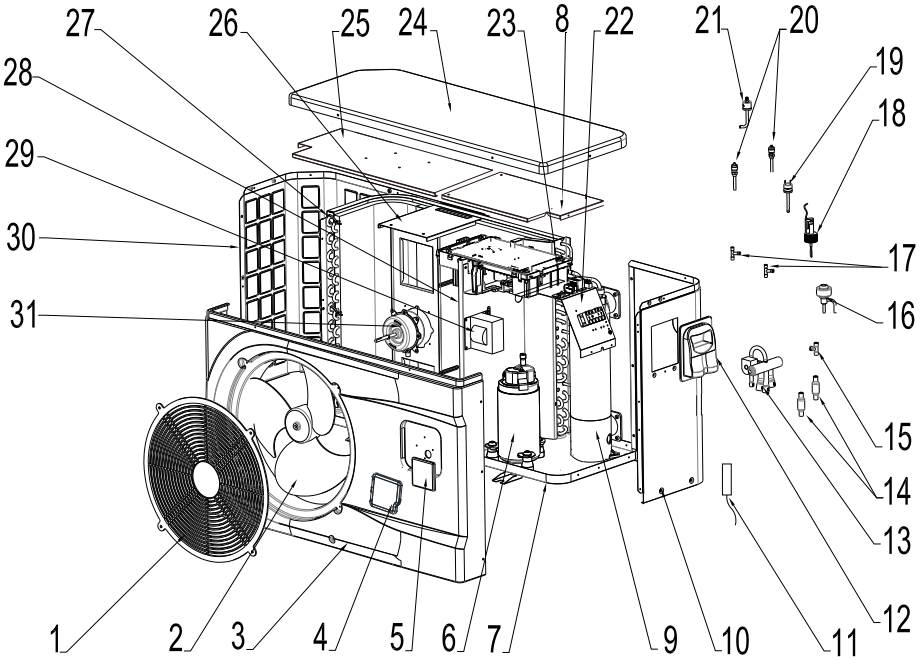



## 6. APPENDIX (continued)

Mark	Description	Ref.	ECL115MA*	ECL120MA*	ECL130MA*	ECL140MA*
27	Fin coil	HWX301060202502	✓	n/a	n/a	n/a
		HWX80600042	n/a	✓	n/a	n/a
		HWX80600043	n/a	n/a	✓	n/a
		HWX80600044	n/a	n/a	n/a	✓
28	/	/	/	/	/	
29	16A 50Hz 5mH coil	HWX82500006	✓	✓	✓	n/a
	20A 50Hz 5.2mH coil	HWX82500005	n/a	n/a	n/a	✓
30	Left panel	HWX80700446	✓	✓	✓	n/a
		HWX80700315	n/a	n/a	n/a	✓
		HWX80200018	✓	✓	✓	n/a
31	DC ventilator motor	HWX20000330132	n/a	n/a	n/a	✓
		HWX82300052	✓	✓	✓	n/a
32	Printed circuit board Driver	HWX82300007	n/a	n/a	n/a	✓
		HWX82600008	✓	✓	✓	✓
33	230V~/12VDC transformer	HWX82600008	✓	✓	✓	✓
34	Terminal block L-N-GND -5 connections 4mm <sup>2</sup>	HWX40003901	✓	✓	✓	✓
35	K2 relay	HWX20000360297	✓	✓	✓	✓

(\*) Check the machine references on the conversion table (see label on the cover of the manual).

## 6. APPENDIX (continued)

### 6.4 Troubleshooting guide



**Certain operations must be carried out by an authorized technician.**

If a fault occurs on the heat pump ⚠ appears in the top left-hand corner of the screen.

Refer to following table.



**When the problem is resolved, the error is automatically acknowledged and the triangle disappears.**

- To delete the error list, press on **Del**.
- Press 2 times on **○** to return to the main screen.

## 6. APPENDIX (continued)

Problem	Error codes	Description	Solution
Water inlet sensor fault	P01	The sensor is open or has short-circuited.	Verify the CN21/RES1 connectors on the board and the extension connector or replace the sensor
Water outlet sensor fault	P02		Verify the N22/RES2 connectors on the board and the extension connector or replace the sensor
Outside temperature sensor fault	P04		Verify the CN12/PH connectors on the board and the extension connector or replace the sensor
De-icing sensor fault	P05		Verify the CN8/OPT connectors on the board and the extension connector or replace the sensor
Compressor aspiration sensor defect	P07		Verify the CN7/OAT connectors on the board and the extension connector or replace the sensor
Compressor discharge sensor fault	P081		Verify the CN9/OHT connectors on the board and the extension connector or replace the sensor
High pressure protection	E01	The sensor is open or has short-circuited.	Verify the CN30/HP connectors on the card or replace the sensor Check the water flow Check the water flow detector Check the valve opening Check the by-pass Check the evaporator is not clogged Water temperature too hot Incondensable problem after maintenance, empty and evacuate the cooling circuit Fluid load too high, remove fluid into a liquid bottle
Low pressure protection	E02	The sensor is open or has short-circuited.	Check the AI/DI03 connections on the card or replace the sensor Large coolant leak, search for the leak with the detector Air flow too low, check the ventilator rotation speed Check the evaporator is not clogged, clean its surface
Flow sensor fault	E03	The sensor is open or has short-circuited.	Check the AI/DI02 connections on the card or replace the sensor Lack of water, check the filtration pump operation Check the stop valve opening Check the by-pass adjustment

## 6. APPENDIX (continued)

Problem	Error codes	Description	Solution
Input/Output temperature difference > 13°C	E06	Applicable in Cold mode only	Lack of water, check the filtration pump operation
			Check the stop valve opening
			Check the by-pass adjustment
Antifreeze protection Cold mode	E07	Water output temperature < 4°C	Stop the heat pump, empty the condenser risk of freezing
Communication problem	E08	No communication between the printed circuit board and the user interface	Check the connectors - see the wiring diagram
Level 1 antifreeze protection	E19	2° < Water temperature < 4° and Air temperature < 0°	Stop heat pump operation, empty the condenser to avoid freezing, by default the heat pump starts the filtration pump to avoid icing over
Level 2 antifreeze protection	E29	Water temperature < 2° and Air temperature < 0°	Stop heat pump operation, empty the condenser to avoid freezing, by default the heat pump starts the filtration pump and the heat pump to avoid icing over.
Fan motor fault	F031	Motor jammed or faulty connection	Check free rotation; check CN97/DC connectors; replace the motor
Fan motor fault	F051	Faulty connection	Check the DCFAN/CN97 connector; replace the motor
Exterior temperature too low	TP	Operating limit reached	Stop the heat pump

## 6. APPENDIX (continued)

---

### 6.5 Warranty

#### WARRANTY CONDITIONS

All HAYWARD products are guaranteed to be free from manufacturing or material faults for a period of two years as from the date of purchase. Any claim made under the terms of the warranty must be accompanied by a dated proof of purchase. We therefore recommend that you keep your invoice.

The HAYWARD warranty is limited to the repair or replacement, at HAYWARD's discretion, of faulty products, provided they have been used under normal conditions, as described in their user guide, and that the product has not been modified in any way and has been used only with HAYWARD components and parts. Frost and chemical damage are not covered.

No other costs (transportation, labour, etc.) are covered by the warranty.

HAYWARD cannot be held liable for any direct or indirect damage caused by the incorrect installation, connection or operation of a product.

Please contact your retailer if you want to make a claim under the terms of the warranty and request the repair or replacement of an item. No equipment returned to our factory will be accepted without our prior written agreement.

Worn parts are not covered by the warranty.

---

*Page left intentionally blank*